

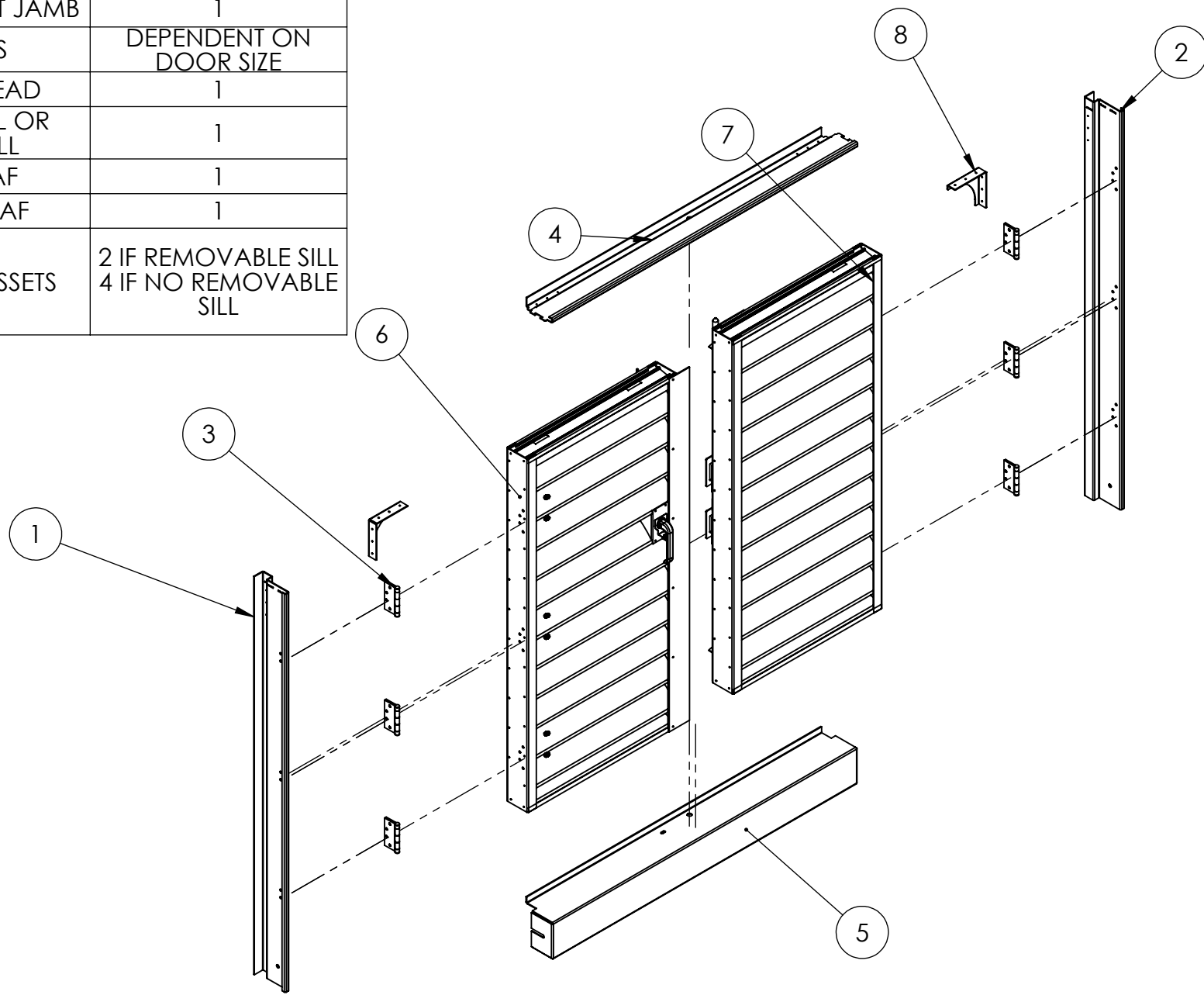

#	Description	QTY/ASSEMBLY
1	DOOR FRAME LEFT JAMB	1
2	DOOR FRAME RIGHT JAMB	1
3	DOOR HINGES	DEPENDENT ON DOOR SIZE
4	DOOR FRAME HEAD	1
5	DOOR FRAME SILL OR REMOVABLE SILL	1
6	LEFT DOOR LEAF	1
7	RIGHT DOOR LEAF	1
8	DOOR FRAME GUSSETS	2 IF REMOVABLE SILL 4 IF NO REMOVABLE SILL



FOR: 	QTY:	ORDER #	DESCRIPTION: DOOR IOM		222 CHURCH ST. S ALLISON, ON L9R2B7 TEL: 905-857-4700 FAX: 905-857-4750 TOLL FREE: 1-800-668-7214 WWW.VENTEXINC.COM	MATERIAL: AL	FINISH:	DRAWN BY: T.SMITH	DATE: 2022-03-14	PART LIST of 6	SCALE 1:20 DO NOT SCALE DRAWING	REVISION 0	SIZE A
S:\Specifications\Engineering\VON gdb\2420 HBD 59.500 X 60.000 WITH CANE BOLT LOCK 6 INCH EXT SILL 42380\				UNLESS SPECIFIED ALL DIMENSIONS ARE IN INCHES. DIMENSIONS IN () ARE METRIC. TOLERANCES ON: .X=±.0625 (X=1.6), .XX=±0.03 (X.X=0.8), .XXX=±0.01 (X=0.3), ANGLES X°=±1°, .X°=±0.5				UNITS: INCHES (mm) REMOVE ALL BURRS & SHARP CORNERS		SW FILE NUMBER: 2420 HBD 59.500 X 65.500 ' ' WITH CANE BOLT LOCK - 6 INCH EXT SILL 42380			

1)

ATTACH HINGES TO DOOR FRAME JAMB
REPEAT THIS STEP FOR OTHER DOOR FRAME JAMB

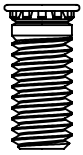

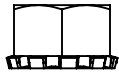

4 PER HINGE
* INSTANCES WHERE
ONLY THREE WILL APPLY

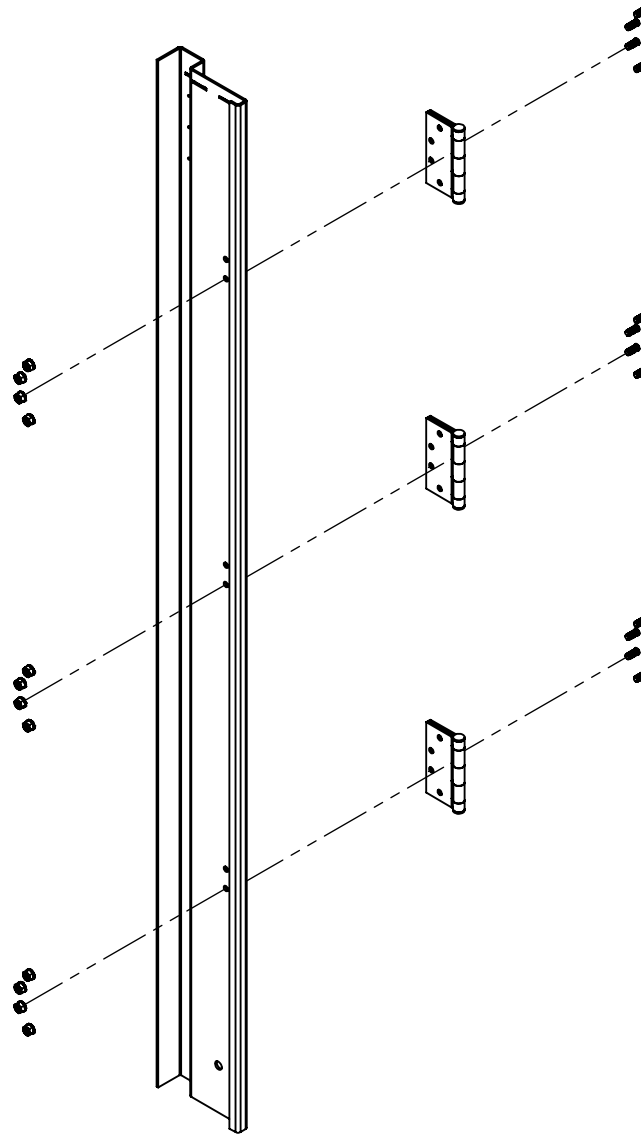

4 PER HINGE
* INSTANCES WHERE
ONLY THREE WILL APPLY



FOR: 	QTY:	ORDER #	DESCRIPTION: DOOR IOM		222 CHURCH ST. S ALLSTON, ON L9R2B7 TEL: 905-857-7700 FAX: 905-857-4730 TOLL FREE: 1-800-668-7214 www.ventexinc.com	MATERIAL: AL	FINISH:	DRAWN BY: T.SMITH	DATE: 2022-03-14	1 of 6	SCALE 1:10 DO NOT SCALE DRAWING	REVISION 0	SIZE A
S:\Specifications\Engineering\VON gdb\2420 HBD 59.500 X 60.000 WITH CANE BOLT LOCK 6 INCH EXT SILL 42380\				UNLESS SPECIFIED ALL DIMENSIONS ARE IN INCHES. DIMENSIONS IN () ARE METRIC.		UNITS: INCHES (mm) REMOVE ALL BURRS & SHARP CORNERS		SW FILE NUMBER: 2420 HBD 59.500 X 65.500 ' ' WITH CANE BOLT LOCK - 6 INCH EXT SILL 42380					
				TOLERANCES ON: .X=±.0625 (X=1.6), .XX=±0.03 (X.X=0.8), .XXX=±0.01 (X=0.3), ANGLES X°=±1°, .X°=±0.5									

2)

ATTACH HINGES TO DOOR JAMB
REPEAT THIS STEP FOR OTHER DOOR FRAME JAMB

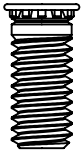

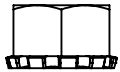

4 PER HINGE
* INSTANCES WHERE
ONLY THREE WILL APPLY

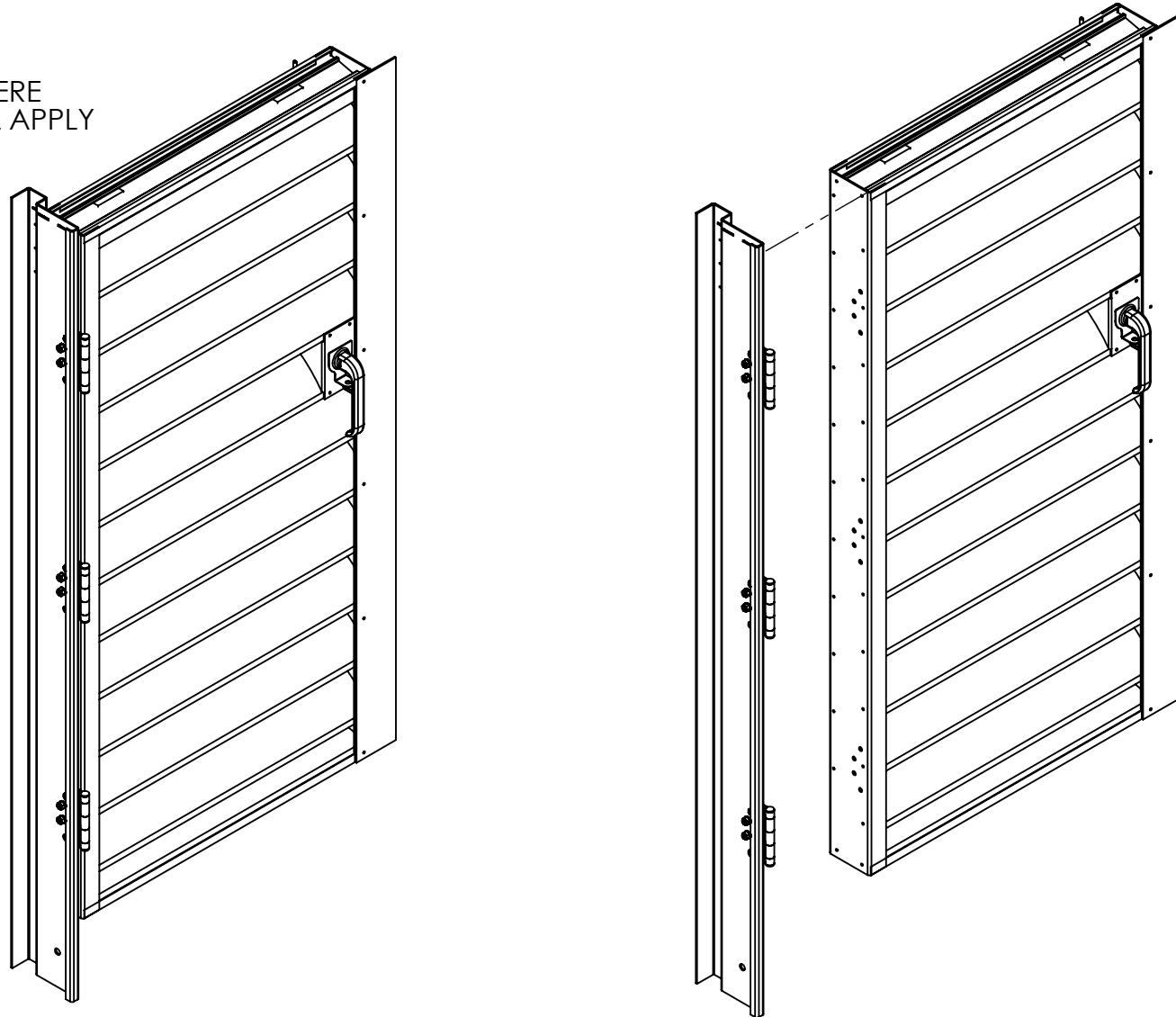

4 PER HINGE
* INSTANCES WHERE
ONLY THREE WILL APPLY



FOR: 	QTY:	ORDER #	DESCRIPTION: DOOR IOM		222 CHURCH ST. S ALLISTON, ON L9R 2B7 TEL: 905-857-4700 FAX: 905-857-4730 TOLL FREE: 1-800-668-7214 www.ventexinc.com	MATERIAL: AL	FINISH:	DRAWN BY: T.SMITH	DATE: 2022-03-14	2 of 6	SCALE: 1:24 DO NOT SCALE DRAWING	REVISION: 0	SIZE: A
S:\Specifications\Engineering\VON gdb\2420 HBD 59.500 X 60.000 WITH CANE BOLT LOCK 6 INCH EXT SILL 42380\				UNLESS SPECIFIED ALL DIMENSIONS ARE IN INCHES. DIMENSIONS IN () ARE METRIC.		UNITS: INCHES (mm) REMOVE ALL BURRS & SHARP CORNERS		SW FILE NUMBER: 2420 HBD 59.500 X 65.500 '' WITH CANE BOLT LOCK - 6 INCH EXT SILL 42380					
				TOLERANCES ON: .X=±.0625 (X=1.6), .XX=±0.03 (X.X=0.8), .XXX=±0.01 (X=0.3), ANGLES X°=±1°, .X°=±0.5									

3)

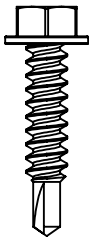
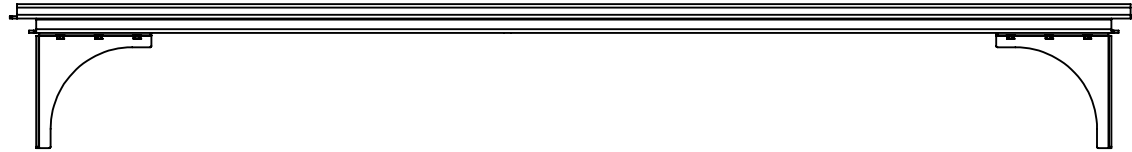
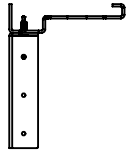

ATTACH FRAME GUSSETS TO HEAD ON BOTH SIDES
REPEAT ON SILL IF NOT A REMOVABLE SILL

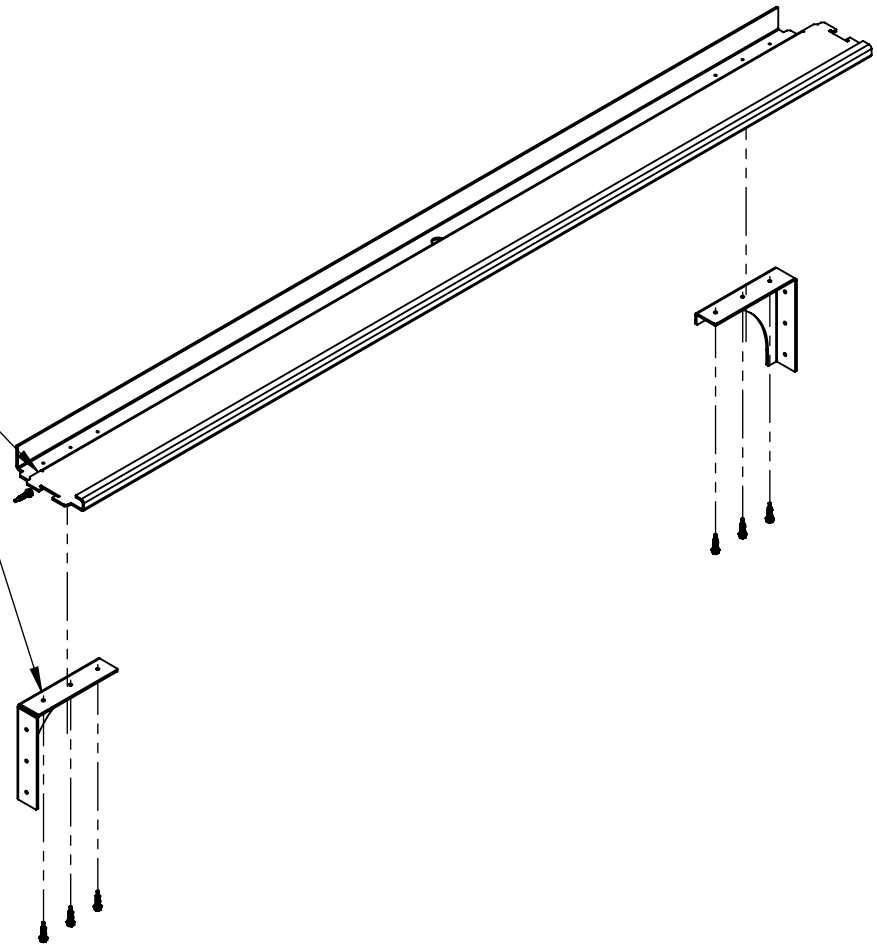

3 PER GUSSET

HOLES TO SET LOCATION OF GUSSETS



FOR: 	QTY:	ORDER #	DESCRIPTION: DOOR IOM		222 CHURCH ST. S ALLISTON, ON L9R2B7 TEL: 905-857-4790 FAX: 905-857-4790 TOLL FREE: 1-800-668-7214 www.ventexinc.com	MATERIAL: AL	FINISH:	DRAWN BY: T.SMITH	DATE: 2022-03-14	3 of 6	SCALE 1:10 DO NOT SCALE DRAWING	REVISION 0	SIZE A
S:\Specifications\Engineering\VON gdb\2420 HBD 59.500 X 60.000 WITH CANE BOLT LOCK 6 INCH EXT SILL 42380\				UNLESS SPECIFIED ALL DIMENSIONS ARE IN INCHES. DIMENSIONS IN () ARE METRIC.		UNITS: INCHES (mm) REMOVE ALL BURRS & SHARP CORNERS			SW FILE NUMBER: DOOR FRAME 2420 HBD 59.500 X 65.500 '' WITH CANE BOLT LOCK - 6 INCH EXT SILL 42380				
TOLERANCES ON: .X=±.0625 (X=1.6), .XX=±0.03 (X.X=0.8), .XXX=±0.01 (X=0.3), ANGLES X°=±1°, .X°=±0.5													

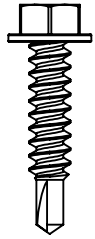

4)

SUGGESTED TO DO THIS STEP WITH PARTS LAYING ON THE FRONT FACE ON A LARGE PEICE OF CARDBOARD
 ATTACH BOTH DOOR LEAFS TO HEAD AND SILL IF NOT A REMOVABLE SILL

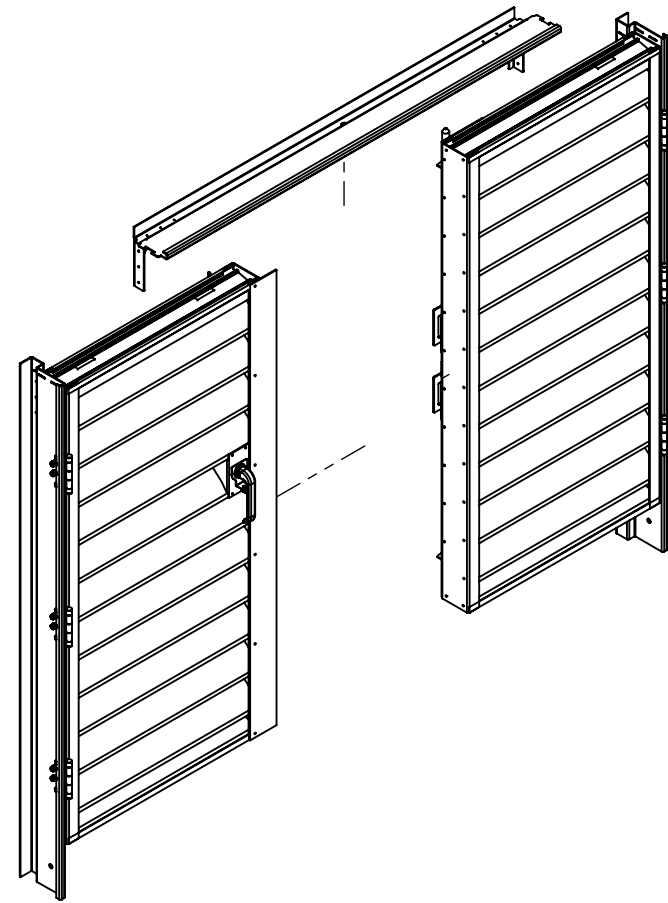
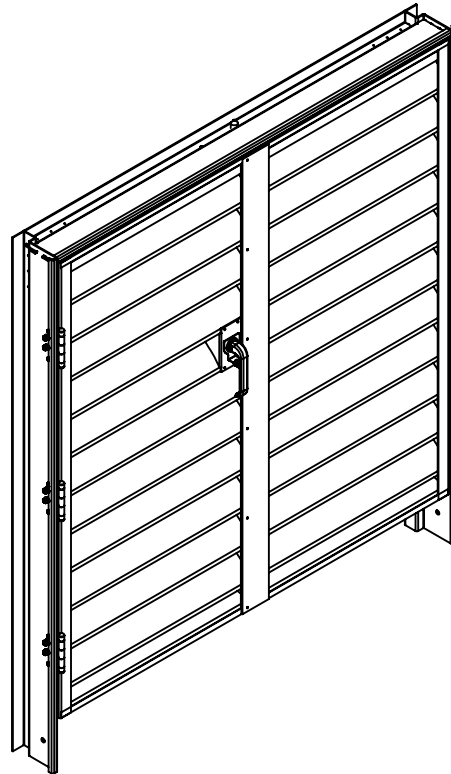

3 PER GUSSET



FOR: 	QTY:	ORDER #	DESCRIPTION: DOOR IOM		222 CHURCH ST. S ALLISTON, ON L9R2B7 TEL: 905-867-4700 FAX: 905-867-4730 TOLL FREE: 1-800-668-7214 www.ventexinc.com	MATERIAL: AL	FINISH:	DRAWN BY: T.SMITH	DATE: 2022-03-14	4 of 6	SCALE: 1:20 DO NOT SCALE DRAWING	REVISION: 0	SIZE: A
S:\Specifications\Engineering\VON gdb\2420 HBD 59.500 X 60.000 WITH CANE BOLT LOCK 6 INCH EXT SILL 42380\			UNLESS SPECIFIED ALL DIMENSIONS ARE IN INCHES. DIMENSIONS IN () ARE METRIC.		TOLERANCES ON: .X=±.0625 (X=1.6), .XX=±0.03 (X.X=0.8), .XXX=±0.01 (X=0.3), ANGLES X°=±1°, .X°=±0.5		UNITS: INCHES (mm) REMOVE ALL BURRS & SHARP CORNERS		SW FILE NUMBER: 2420 HBD 59.500 X 65.500 ' ' WITH CANE BOLT LOCK - 6 INCH EXT SILL 42380				

5)

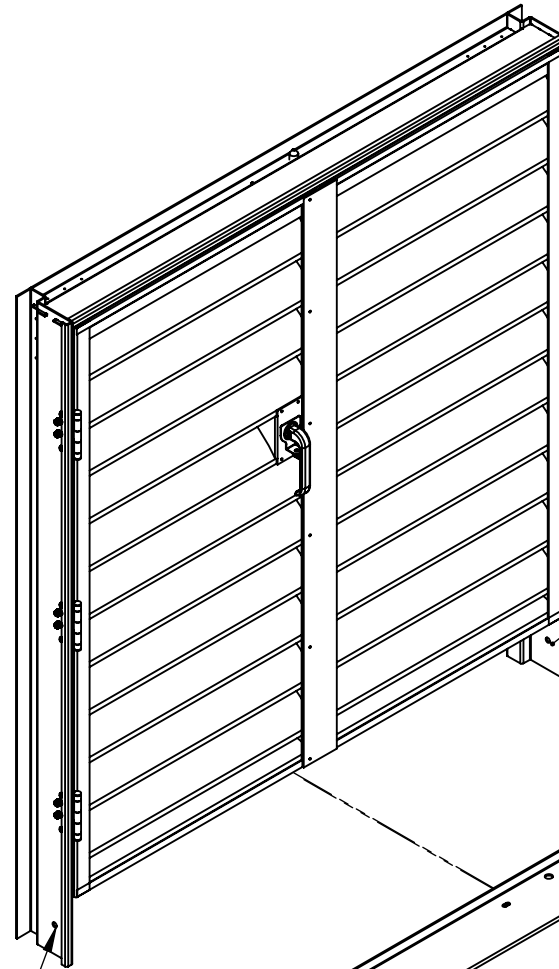
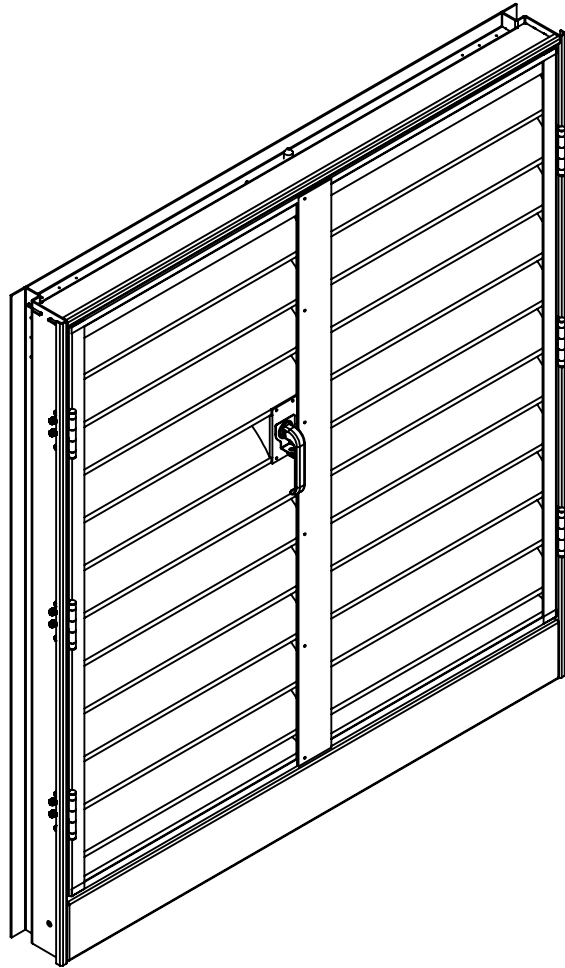

INSTALL DOOR AND ATTACH REMOVABLE SILL

PLEASE INSURE THE DOOR IS INSTALLED SQUARE AND FASTENED PROPERLY TO PREVENT BOWING/SAGGING



BOLTS NOT INCLUDED

BOLTS NOT INCLUDED

FOR: 	QTY:	ORDER #	DESCRIPTION: DOOR IOM		222 CHURCH ST. S ALLISTON, ON L9R2B7 TEL: 905-857-4700 FAX: 905-857-4730 TOLL FREE: 1-800-668-7214 WWW.VENTEXINC.COM	MATERIAL: AL	FINISH:	DRAWN BY: T.SMITH	DATE: 2022-03-14	5 of 6	SCALE: 1:16 DO NOT SCALE DRAWING	REVISION: 0	SIZE: A
S:\Specifications\Engineering\VON gdb\2420 HBD 59.500 X 60.000 WITH CANE BOLT LOCK 6 INCH EXT SILL 42380\				UNLESS SPECIFIED ALL DIMENSIONS ARE IN INCHES. DIMENSIONS IN () ARE METRIC.		UNITS: INCHES (mm)		SW FILE NUMBER: 2420 HBD 59.500 X 65.500 '' WITH CANE BOLT LOCK - 6 INCH EXT SILL 42380					
				TOLERANCES ON: .X=±.0625 (X=1.6), .XX=±0.03 (X.X=0.8), .XXX=±0.01 (X=0.3), ANGLES X°=±1°, .X°=±0.5		REMOVE ALL BURRS & SHARP CORNERS							